



CUSTOMIZED CERAMIC TECHNOLOGIES FOR SPACE AND ASTRONOMY

High-performance ceramics

OUR STRENGTH – WIDE VARIETY OF CUSTOMIZED CERAMIC MATERIALS

Our cutting-edge technology is used around the world in multiple fields. Kyocera provides over 200 kinds of ceramics materials designed to meet the individual needs. High-performance ceramics are precisely engineered materials with unique properties that are not present in naturally occurring materials. These properties, such as electrical conductivity and heat resistance, allow them to stand up to conditions other materials cannot. In this way, our technical ceramics help make the impossible, possible.



ALUMINA

Alumina is the most widely used material among fine ceramics, and exists under two distinct structures: polycrystal (sintered alumina) or monocrystal (sapphire). Its applications are diverse due to its superb properties such as high insulation, high strength, high wear resistance and chemical resistance.



SILICON NITRIDE

Silicon nitride is a material with excellent specific strengths and very good thermal shock coefficient up to application temperatures of 1,100°C. The low thermal expansion in combination with high stiffness, strength and fracture toughness qualifies the material especially for applications where abrasion and thermal shock are major problems. Typical applications are lightweight fixtures and turbine components.



SILICON CARBIDE

Silicon carbide retains its strength at elevated temperatures as high as 1,400°C. In its sintered form (sintered SiC – SSiC) it features high corrosion resistance. As silicon-infiltrated SiC – SiSiC, high precision parts with fine detailed, hollow and complex structures can be manufactured. Applications include frames and structures for temperature controlled mirrors and observation optics.



ZIRCONIA

Zirconia offers high strength and toughness. Before zirconia, ceramics were considered impractical for scissors or knife applications. With its excellent properties, zirconia is also used for engineering applications such as pumps.

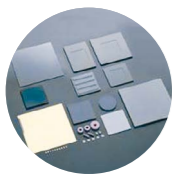

SPECIAL CERAMICS

Our portfolio also includes other ceramics such as aluminum nitride, aluminium titanate, single crystal sapphire, ferrites, dielectric ceramics and **special materials like cordierite**. Each of the materials has a customized application.

CERAMIC MATERIALS WITH OUTSTANDING PROPERTIES

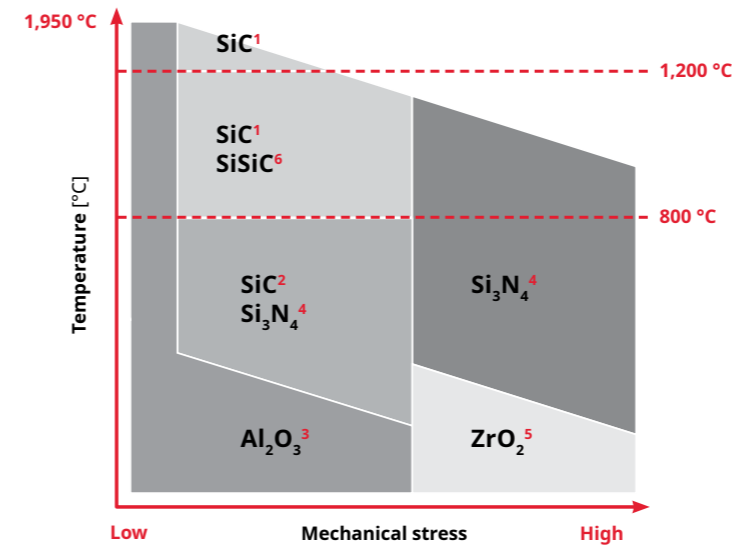

KEY PROPERTIES

- ▶ Extraordinary specific stiffness
- ▶ Temperature change resistance
- ▶ High-temperature resistance

- High strength and corrosion resistance at elevated temperatures
- High strength at temperatures < 800°C in vacuum or de-oxidation atmosphere
- Versatile material that can be used in various temperature ranges
- High strength and fracture toughness even at elevated temperatures
- Good fracture toughness under high stresses
- High rigidity and 0% shrinkage in sintering for precision parts

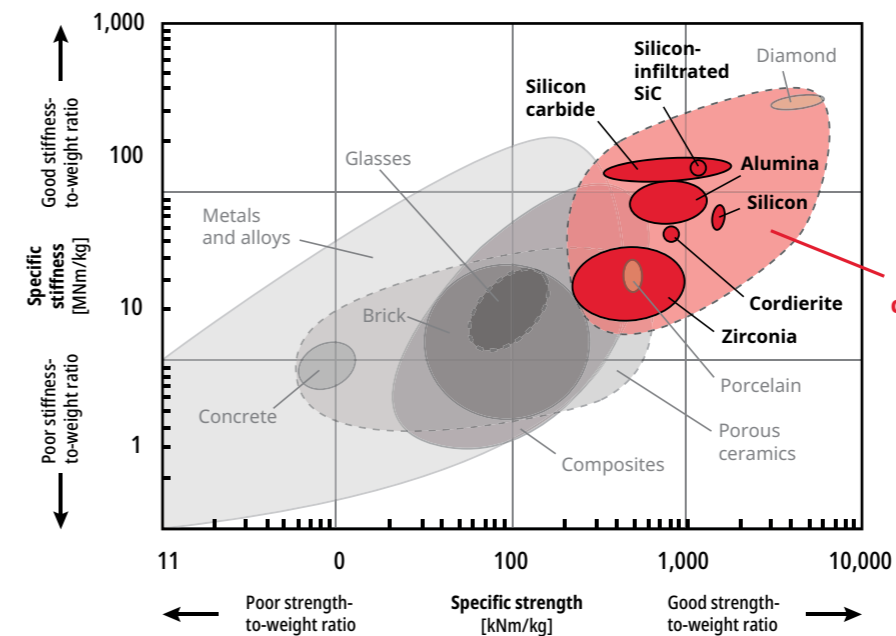

Ceramics chart shows compressive strength

This is an excerpt of "The Mechanical Properties of Natural Materials. I. Material Property Charts" M. F. Ashby, L. J. Gibson, U. Wegst and R. Olive Proceedings: Mathematical and Physical Sciences Vol. 450, No. 1938 (Jul. 8, 1995), pp. 123-140 (18 pages) Published by: Royal Society

VERTICAL INTEGRATED PRODUCTION

Kyocera is one of the few companies on the market that carries out all production steps itself. This vertical integration gives the company extensive control over technologies, quality and production.

Kyocera's wide variety of measurement and evaluation technologies and resources not only support the quality improvement of our ceramic parts, but also enhance customer products and R&D. Kyocera has strong problem-solving capabilities for a wide range of issues.

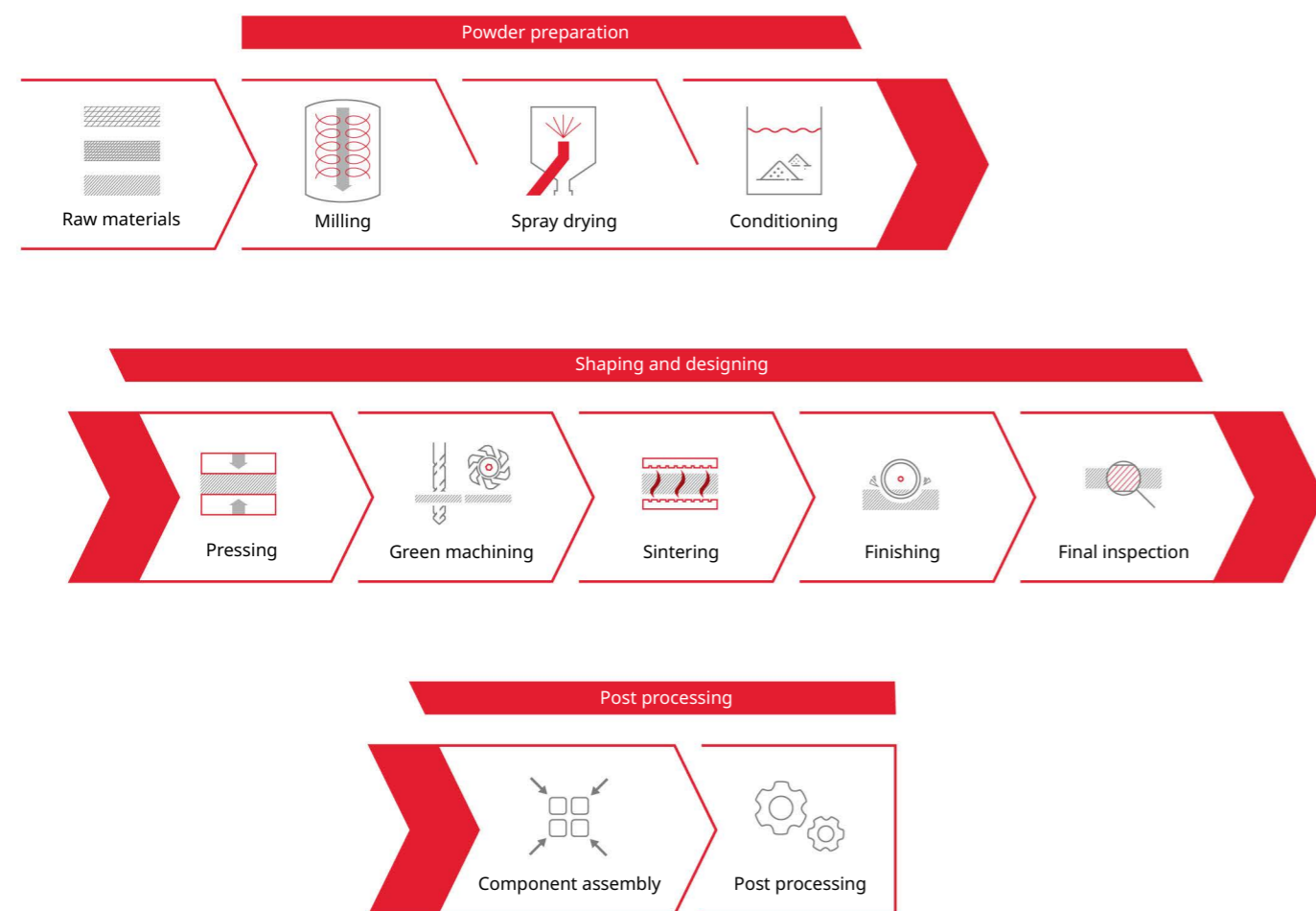

Vertically integrated production from raw material to the final product

100% Kyocera development
▶ vertical integration
▶ 100% quality product

MATERIALS FOR SPACE & ASTRONOMY APPLICATIONS

CORDIERITE (CO2200 / CO7200)

Cordierite is an extremely low thermal expansion ceramic which was developed over two decades back, and we have been constantly improving on its characteristics since.

MATERIAL PROPERTIES

- ▶ **Minimal temperature deformation** due to unique material composition with an extremely low thermal expansion rate
- ▶ **Approx. 70% weight reduction** when compared to low CTE glass¹ with a slim ribbed structure design featuring high rigidity
- ▶ Cordierite is **applicable for structural components** by its superior mechanical property

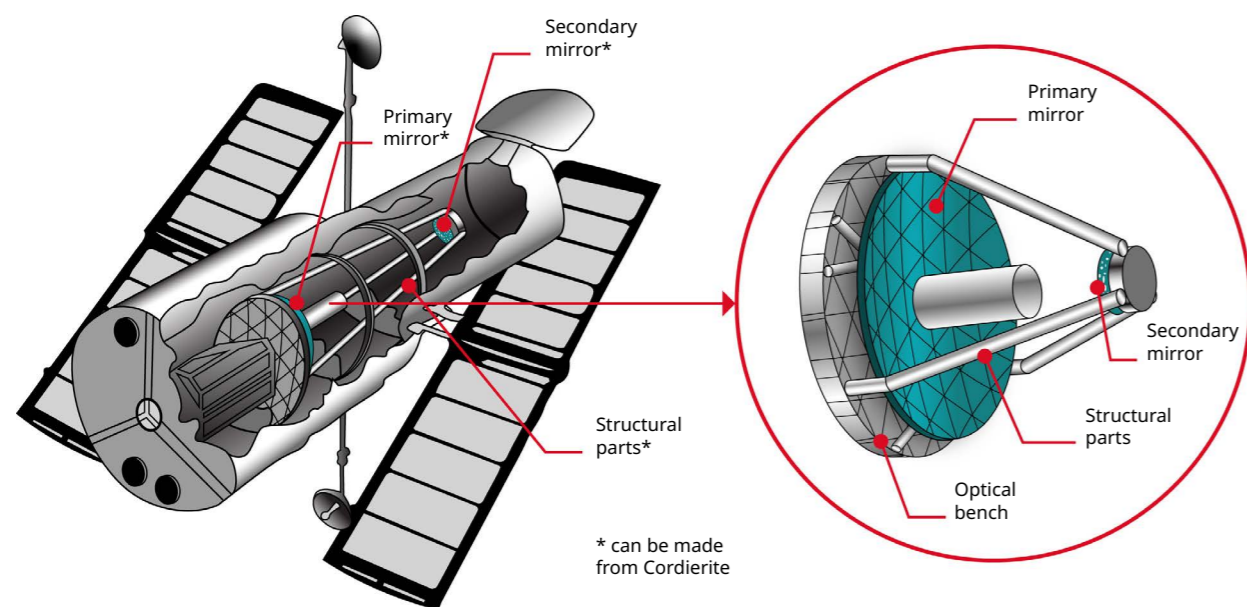
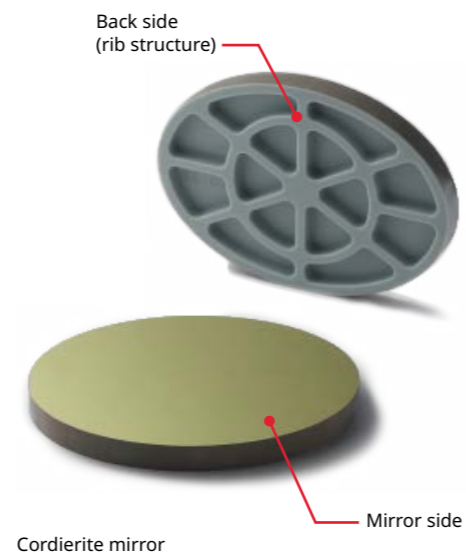

Structural parts made of ceramics in a satellite

TEMPERATURE DEPENDENCY GRAPH <CORDIERITE CO720>

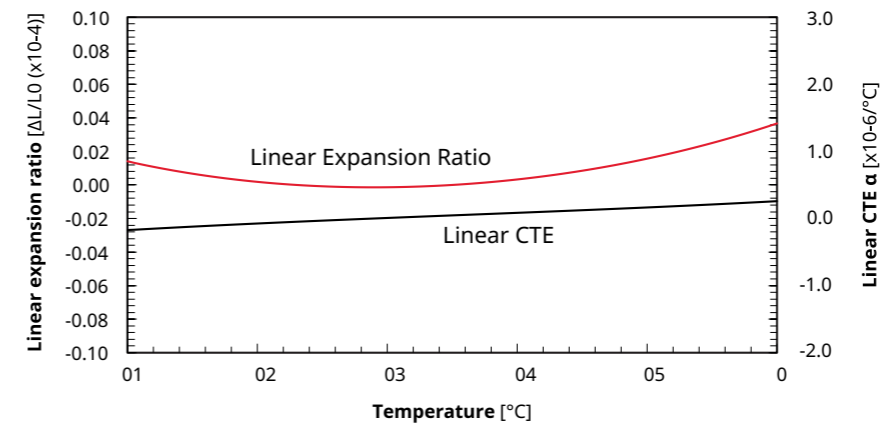

MATERIAL PROPERTIES COMPARISON WITH LOW CTE GLASS

Properties	Unit	Low CTE glass	Cordierite CO720
Density	g/cm ³	2.53	2.55
CTE ²	ppm/K	0.02	0.02
Young's modulus	GPa	90	144
Specific rigidity	-	36	56

3-POINT SUPPORTED DEFLECTION¹

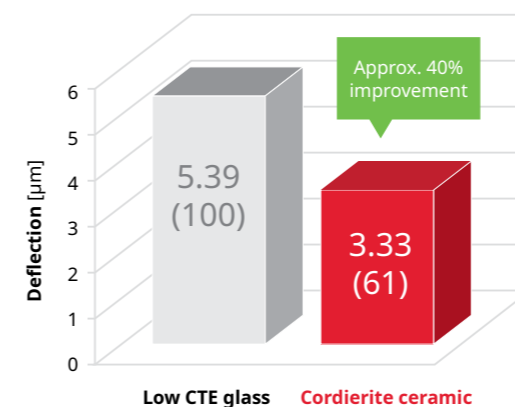

Comparison conditions
 Product size: Ø 1,020 x 120 mm (rib structure)
 Supported points: outside 3 points
 Load: self-weight

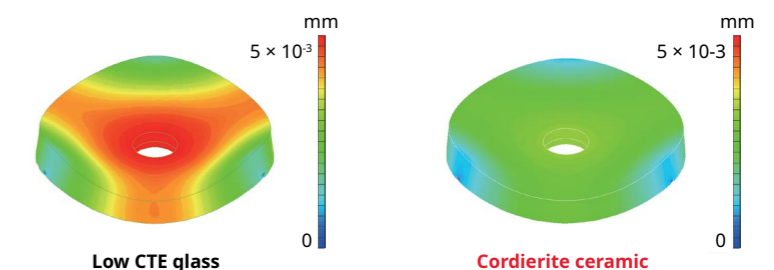

The values are typical material properties and may vary according to product configuration and manufacturing process.

¹ based on Kyocera's research
² temperature dependency graph

SILICON-INFILTRATED SILICON CARBIDE (SiSiC)

Proprietary joining and manufacturing technology for SiSiC enables complex, high precision components with unique design features:

- ▶ Hidden internal cavities possible (e.g. cooling channels)
- ▶ Complex and fine detailed structures below 1 mm achievable
- ▶ Large-scale parts monolithically up to 950 x 950 x 650 mm and larger via proprietary joining technologies
- ▶ High strength, extreme stiffness and reliability components at lowest weight
- ▶ Joining areas with identical material properties, such as Young's modulus and strength

MATERIAL PROPERTIES

- ▶ **Closed porosity** for water and gas tightness requirements
- ▶ **Superior impurity levels** by utilization of semiconductor grade constituents
- ▶ **Extremely homogeneous material** through large-scaled part

	StarCeram® Si SiSiC
SiC	> 85 wt%
Si	balance
Cu	< 3 ppm

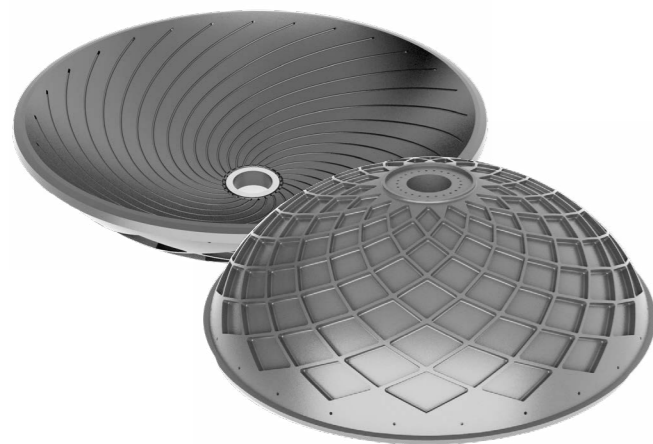

Mirror with central metal connector and fusion bonding for internal cooling channels



Structural frame for measurement optic

SILICON CARBIDE (SSiC)

Excellent SSiC material properties enable applications up to 1600 °C requiring high mechanical and chemical resistance.

MATERIAL PROPERTIES

- ▶ **Excellent chemical resistance** from basic to acidic materials allowing applications in harsh environments
- ▶ Large-scaled parts with **outstanding high-temperature performance** answering the demanding needs of the aerospace industry

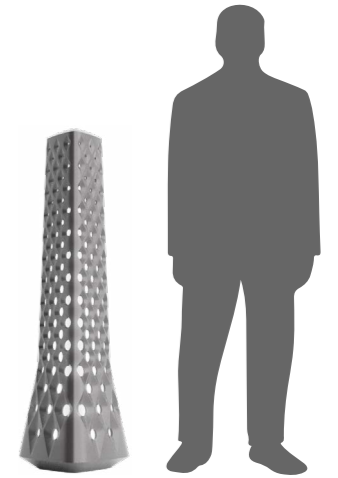

Extraordinary specific stiffness allows large structural components

Properties	Unit	StarCeram® Si SSiC	StarCeram® Si SiSiC
Density	g/cm ³	3.13	3.05
Fracture strength	MPa	375	300
Young's modulus	GPa	395	380
Thermal conductivity	W/mK	125	200
CTE (RT -1,000 °C)	x10 ⁻⁶ K ⁻¹	4.5	4.0
Resistivity RT	Ωm	10 ⁴	10 ⁻²
Thermal shock coefficient R1	K	180	190
Max. working temperature	°C	1,600	1,350

CHEMICAL RESISTANCE



ALUMINA (Al₂O₃) AND ZIRCONIA (ZrO₂)

Kyocera's oxide ceramics display operational safety, reliability and long lifetime.

Brazed oxide ceramic-to-metal assemblies outreach the excellent properties of ceramics and metal. Ceramics show electrical insulation; metal components feature weldability. This advantageous combination enables a wide range of vacuum, high-voltage and high-pressure applications.

MATERIAL PROPERTIES

- ▶ Mechanical strength
- ▶ High chemical resistance
- ▶ Good thermal shock resistance at high and low temperatures
- ▶ Good thermal conductivity
- ▶ Excellent electrical resistance
- ▶ Low dielectric loss at high frequency



Pressure sensor for aerospace

Properties	Unit	Alumina F99.7 α-Al ₂ O ₃	Zirconia FZM ZrO ₂ , MgO
Purity	wt-%	> 99.7	> 99.7
Density	g/cm ³	≥ 3.9	≥ 5.7
Bending strength	MPa	350	500
Max. working temperature	°C	1,950	900

Vacuum, high-voltage and high-pressure applications

SPACE & ASTRONOMY APPLICATIONS

From extreme temperatures to cosmic rays, the unforgiving environment of space means most organic materials used here on earth are rendered useless for many critical applications. The solution for this problem: high-performance ceramics from Kyocera.

From ceramic tubes for oxygen sensors to battery insulators, telescope spacers, and satellite applications, components made of technical ceramics provide the reliability and performance needed for space-specific applications. We are proud to support the explorers unravelling the mysteries of the universe with cutting-edge solutions.

CAMERA LENS SPACER

Subaru Telescope is an 8.2-meter (320 inch) optical-infrared flagship telescope operated by the National Astronomical Observatory of Japan (NAOJ), located at the Mauna Kea Observatory on Hawaii.

In 2012, when NAOJ installed a new super wide angle camera "Hyper Suprime-Cam (HSC)" into the Subaru Telescope, there were two design requirements for adaptive optics. One was to make a larger lens aperture and the other was to make the lens lighter.

Kyocera's cordierite was chosen as the best material to achieve the two design requirements for the lens support. Cordierite's superior characteristics enabled a slim design with enough material strength and rigidity to support the lens structure as well as minimal deformation due to temperature fluctuations.

970 mm



HSC module

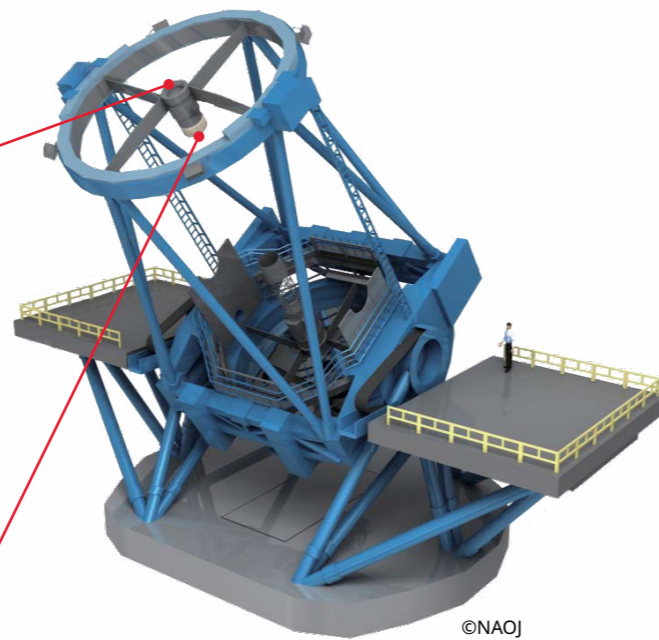

©NAOJ

Subaru Telescope support structure

Lens support made by Kyocera's low CTE ceramic cordierite CO720



©NAOJ

Subaru Telescope
on Hawaii equipped with
Kyocera's cordierite ceramics

OPTICAL SYSTEMS INCLUDING MIRRORS

Kyocera has developed diffraction-limited off-axis reflective optical systems (mirrors, mirror holders, and optical benches) made entirely of cordierite materials, with Kyocera's high accuracy assembling technology.

Cordierite was used as it has a great "athermal property" whereby the optical performance does not degrade under varying temperature conditions owing to its monoclinic nature. We were able to process this extremely low thermal expansion ceramic to include cordierite mirrors coated with metal (Au), as seen in the pictures.

Alternatively, larger cordierite mirrors of over 1 meter diameter, can be produced with a light weight design and the required surface roughness.

Such structures are expected to be installed in large telescopes (30 meters) and space telescopes in the coming years.

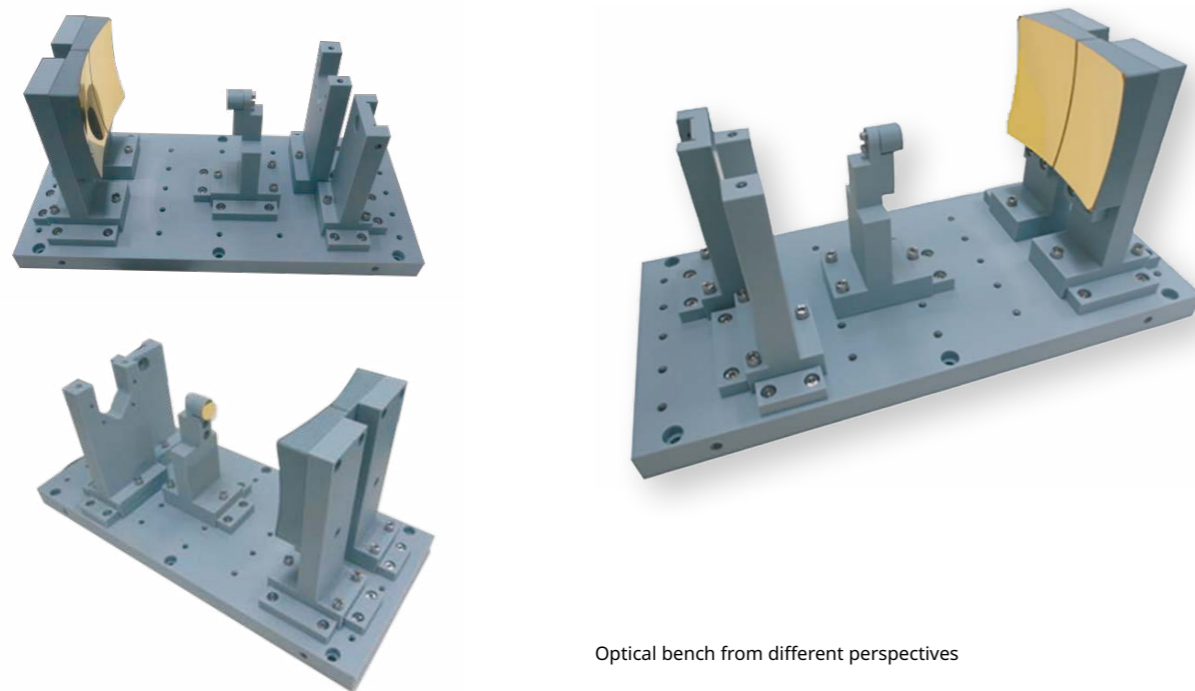

Optical bench from different perspectives

CAMERA HOUSING MADE OF F99.7

In-house 5-axis CNC machining supported by ultrasonic processing allows the manufacture of complex components such as camera housing. The permeability of ceramics for electromagnetic radiation takes effect in this type of application: the electromagnetic waves of the sensors inside the housing can pass through to the outside, while radar beams from outside are hardly reflected thus impeding detection of aircraft.

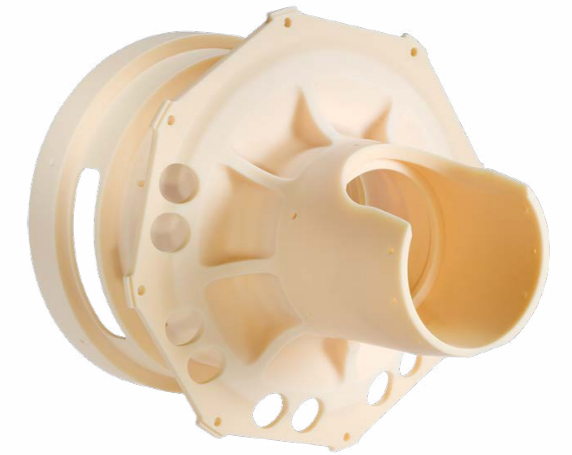

Camera housing

INSULATORS FOR ION THRUSTERS

High electrical insulation and thermal strength of our F99.7 alumina material allow its use in components of ion thrusters. Excellent performance in ultra-high vacuum is guaranteed by minimal desorption and leakage rate. When required, we combine ceramics with metals.

CUSTOMIZED PARTS

Low weight and high corrosion resistance combined with high mechanical strength make our ceramic materials perfectly suitable for space applications. We excel in specific solutions. Our years of experience as a manufacturer of customized and standard components guarantee superior solutions to accomplish a variety of tasks.



Tubes, rods, capillaries for high temperature applications



Beam position monitor

ABOUT KYOCERA



The global Kyocera corporation - a strong partner.

▶ Headquarters:	Kyoto, Japan
▶ Foundation:	1959
▶ Employees:	over 83.000 worldwide
▶ European headquarters:	Esslingen, Germany
▶ European production sites:	Mannheim, Germany Selb, Germany (further subsidiaries in Europe)

 **KYOCERA** = **KYOTO CERAMICS**

KYOCERA – it all began with ceramics

KYOCERA Fin ceramics Europe GmbH is part of KYOCERA Corporation, headquartered in Kyoto, Japan, one of the world's leading manufacturer of high-performance ceramic components for the technology industry. Today, the Kyocera Group offers over 200 different ceramic materials and state-of-the-art technologies and services tailored to the individual needs of each market

KYOCERA Fin ceramics Europe GmbH has grown steadily in recent years – and is now a leading European supplier of customised solutions made of technical ceramics. Working in partnership, we develop and manufacture products that offer our customers added value in their respective markets and secure their technological lead in the long term. We are committed to this every day.

Throughout Europe, we are represented by two production and development sites in Mannheim and Selb, as well as six sales offices –

in Mannheim, Selb, Esslingen, Neuss, Rungis (France) and Frimley (United Kingdom).

Our hearts beat completely for ceramics. Our team provides comprehensive advice on the selection of ceramic materials, product design and project execution – from the development stage to prototyping.

We supply system components for high-tech applications in numerous industries. Our products are characterised by high quality, precision and durability.

Our business partners benefit from the fact that we think and work across divisions within the Kyocera Group. Because innovations and real milestones can only be achieved together – across industries and national borders.

This is what we believe.

About the KYOCERA Group

KYOCERA Corporation (Kyoto) is one of the world's leading manufacturers of high-performance ceramic components for the technology industry. Strategically important business areas of the Kyocera Group, which consists of around 300 subsidiaries, are information and communications technologies, products to improve the quality of life, and environmentally friendly products. The technology group is also one of the most experienced producers of smart energy systems worldwide.

The products marketed by the company in Europe include printers, digital copying systems, semiconductor-, fine ceramic-, automotive- and electronic components as well as printing devices and ceramic kitchen products. Kyocera is represented in Germany by four independent companies:

- KYOCERA Europe GmbH (Esslingen and Neuss),
- KYOCERA Fin ceramics Europe GmbH (Mannheim, Selb, Esslingen and Neuss)
- KYOCERA Automotive and Industrial Solutions GmbH (Dietzenbach)
- KYOCERA Document Solutions GmbH (Meerbusch)

The company also takes an active interest in cultural affairs. The Kyoto Prize, a prominent international award, is presented each year by the Inamori Foundation – established by Kyocera founder Dr. Kazuo Inamori – to individuals worldwide who have contributed significantly to the scientific, cultural, and spiritual betterment of humankind.



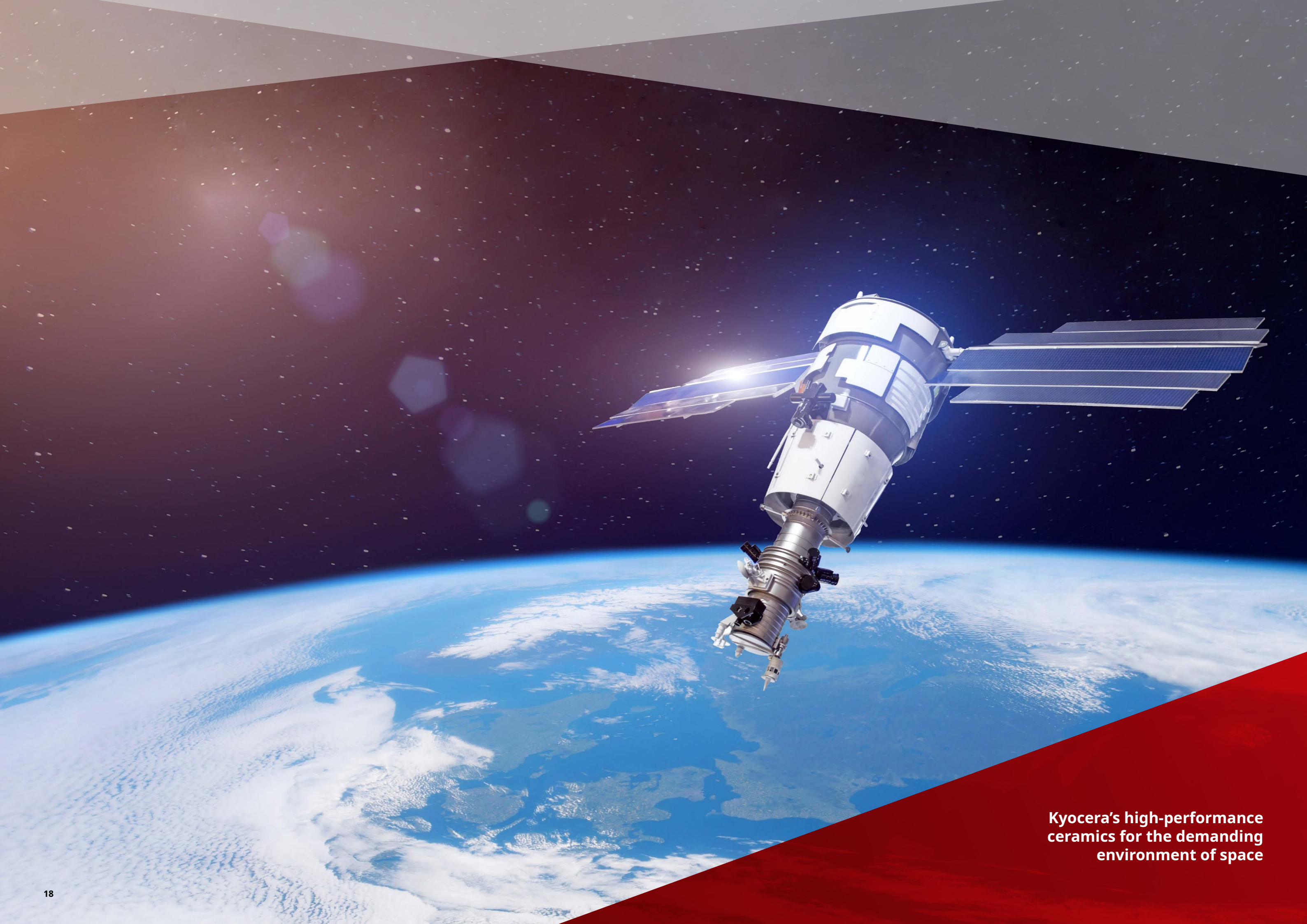

**Kyocera's high-performance
ceramics for the demanding
environment of space**



KYOCERA Fineceramics Europe GmbH

Steinzeugstrasse 92
68229 Mannheim / Germany
Tel: +49 621 40547-300
E-mail: info@kyocera-fineceramics.de
www.kyocera-fineceramics.de/en

Plant Selb

Lorenz-Hutschenreuther-Strasse 81
95100 Selb / Germany
Tel: +49 9287 807-0

Sales office Esslingen

Fritz-Müller-Strasse 27
73730 Esslingen / Germany
Tel: +49 711 93 93 4-0

Sales office Neuss

Hammfelddamm 6
41460 Neuss / Germany
Tel: +49 2131 16 37-0

Sales office Great Britain

Prospect House, Archipelago, Lyon Way
Frimley, Surrey
GU16 7ER / Great Britain
Tel: +44 1276-69 34 50

Sales office France

Parc Icade Orly - Rungis
21 rue de Villeneuve
94150 Rungis / France
Tel: +33 1 41-73 73 30